



**RCMS2304-240**  
**Standalone, Multi Service**  
**Fiber Optic, Ethernet Multiplexer**  
  
**User Manual (REV.B)**

## 1. Cautions



Please read the following notices carefully before installing and using the device, Raisecom does not respond to any loss that caused by violating safety notice.



RCMS2304-240 provides two types of power supply: AC and DC. When using DC power supply, please plug the power supply connectors according to this manual strictly and avoid contrary connecting.



RCMS2304-240 is integrated device that has precise elements, please avoid violent shakes and impacts, and do not disassemble or maintain the device yourself. If it is required, please do it under the guide of our technical staff following in the steps of anti static. Please contact us if there is any need.



There must be grounding protection for the sake of safety; do not disassemble the device yourself, we regard it as you waiver your rights of repair guarantee.

# Content

1.	Cautions .....	1
2.	Overview .....	4
2.1.	Introduction .....	4
2.2.	Main Feature .....	4
2.3.	Number Introduction.....	4
3.	Parameters.....	6
3.1.	E1 Interface.....	6
3.2.	Fast Ethernet .....	6
3.3.	Optical Interface.....	6
3.4.	Auxiliary Data Channel.....	6
3.5.	Power Supply .....	6
3.6.	Ambience .....	6
3.7.	Dimension .....	7
4.	How to use .....	8
4.1.	Introduction of front panel .....	8
4.1.1.	Power indicator .....	8
4.1.2.	Alarm indicator .....	8
4.1.3.	Button .....	9
4.1.4.	DIP-Switch of front panel: (default all "OFF") .....	9
4.1.5.	Ethernet interface.....	12
4.1.6.	RS232 auxiliary data channel .....	12
4.1.7.	LINK UP network management port .....	12
4.2.	Introduction of back panel .....	12
4.2.1.	Optical interface .....	12
4.2.2.	E1 interface.....	12
4.2.3.	SLOT1, SLOT2 expanded slots .....	13
4.2.4.	Power supply socket.....	13
4.3.	DIP-Switch on the bottom panel.....	13
4.3.1.	S1--S4 introduction .....	14
5.	Installation and test .....	15
5.1.	Inspect after Opening.....	15
5.2.	Preparation before Installation .....	15
5.3.	Installation.....	15
5.3.1.	Connecting.....	15
5.3.2.	Electrify .....	16
5.3.3.	Configuring buttons and switches .....	16
6.	Troubleshooting .....	17
7.	Appendix A Introduction of Cable Making .....	19

A.1 E1 interface.....	19
A.2 Cable of Ethernet.....	19
A.3 RS232 cable of data channel.....	19

## 2. Overview

### 2.1. Introduction

RCMS2304-240B is an ideal transmission device of optical fiber for point-to-point networks, medium-sized and small capacity networks, such as wireless communication base stations, private communication networks and switch networks. It can be applied to either public networks or various private networks.

The transmission capacity of RCMS2304-240 is optional. The basic capacity 4 E1 links and 4 Fast Ethernet ports, and the maximum capacity is 8 E1 channels. RCMS2304-240 can be remotely managed.

### 2.2. Main Feature

- Provide standard 4 E1 links, 4 Ethernet ports and one single strand fiber port, the maximum E1 capacity is 8 E1 links
- Implement Fast Ethernet + E1 multi service access
- Auto-adaptive Ethernet port sharing 100M rate bandwidth in fiber
- Ethernet ports communication, or insulation at local end, or communication between local end and relevant remote end
- Control and manage access and bandwidth of customer.
- Provide E1 branch loop-back for opening and maintaining system.
- Alarm of local and remote can be shown at same time.
- Support SNMP management solution. If communicate with RCMS2504-240, native equipment (RCMS2304-240) will be managed by NM server, which connecting with NM port of RCMS2304-240
- Adopt super scale ASIC chip, low power consumption, 4 layers PCB, and high dependability.
- Selectable voltage: AC: 200V and DC: -48V. Built-in power supply
- Power consumption  $\leq 15W$

### 2.3. Number Introduction

Number Illustration:

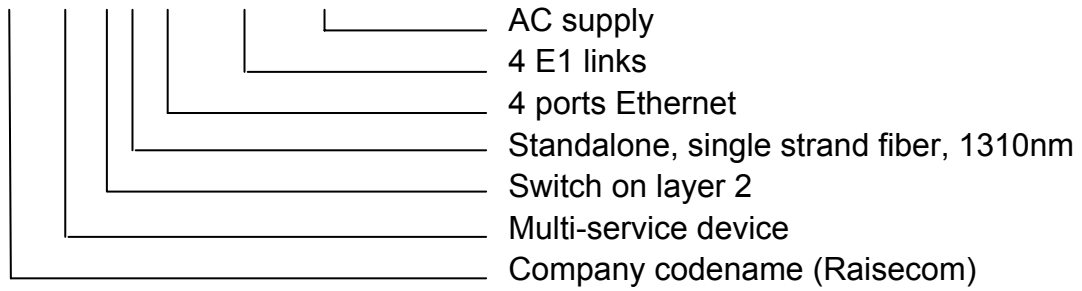
RC MS 2 3 04 – 240 / AC

**Note:** Standalone single strand fiber Ethernet multiplexer: RCMS2304-240 should work with RCMS2504-240, viz. one RCMS2304-240 should connect with one RCMS2504-240.

## 3. Parameters

### 3.1. E1 Interface

Bit rate:	2048Kbps±50ppm
Line code:	HDB3
Impedance of interface:	75Ω (unbalanced BNC interface) or 120Ω (balanced RJ-45 interface)
Electrical characteristics:	complies with ITU-T G.703
Transfer characteristics:	complies with ITU-T G.823
Input jitter tolerance:	complies with ITU-T G.823

### 3.2. Fast Ethernet

Complied with IEEE 802.3 Ethernet, IEEE 802.3u Fast Ethernet  
Complied with IEEE 802.3D Spanning Tree, IEEE 802.1q VLAN  
Supports oversized frame transmission up to 1916 Bytes  
Working mode: 10/100Mbps auto-negotiation, auto-MDI/MDIX (manual setup optional)  
Flow control: IEEE802.3x and back pressure

### 3.3. Optical Interface

Bit rate:	150Mbps
Fiber connector:	SC
Transmission distance:	S1: 0 – 25km; S2: 10 – 50km

### 3.4. Auxiliary Data Channel

RS232 standard, asynchronous, rate: 0~115.2Kbps

### 3.5. Power Supply

DC: -48V (tolerance range -36V ~ -72V)  
AC: 220V (tolerance range 165~265V)  
Power consumption: ≤25W

### 3.6. Ambience

Temperature: 0 ~ 45

Humidity: ≤90% (25 °C)

### **3.7. Dimension**

Standard 19-inch 1U-high chassis

Dimension: 440mm (W)×43.6mm×(H)×235mm(D)



## 4. How to use

### 4.1. Introduction of front panel

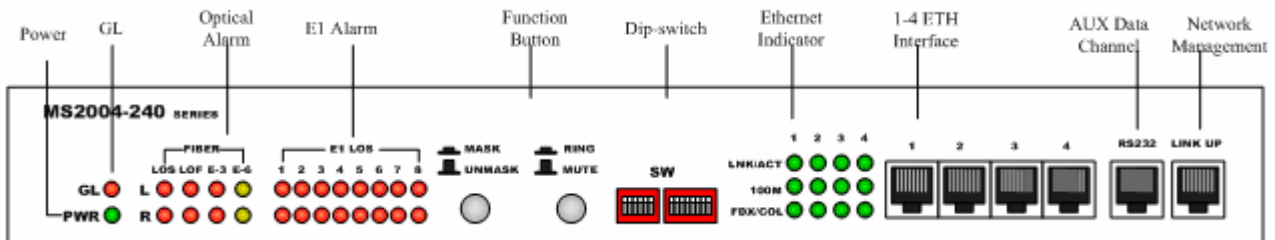

Sketch of RCMS2304-240 front panel

#### 4.1.1. Power indicator

Power indicator (Green): On when the power supply is working in good condition

#### 4.1.2. Alarm indicator

- GL: general alarm  
GL general alarm indicator (red): Any of alarm happened make GL general alarm indicator “on”. Alarm happened on remote site, it is flashing.
- Optical interface  
The row (L) indicates “local”; the row (R) indicates “Remote”  
LOS (red): Optical signal loss, it is on.  
LOF (red): optical signal frame loss, it is flashing or on.  
E-3 (red): optical receiving signal error bit exceeds  $10^{-3}$ , it is flashing.  
E-6 (yellow): optical receiving signal error bit exceeds  $10^{-6}$ , it is flashing.
- E1 loss (The row (L) indicates “local”; the row (R) indicates “Remote”):  
LOS1~8 loss alarm (red): 1<sup>st</sup> ~8<sup>th</sup> E1 LOS alarm. Alarm in local site, E1 LOS is on; alarm on remote site, E1 LOS is flashing; no alarm both on two sides, alarm indicator is off.
- Ethernet indicator (4 groups of indicators corresponds to 4 Ethernet interfaces):  
LNK/ACT (green): receiving or transmitting data, it is flashing.  
100M (green): 100Mbps, it is on; 10Mbps, it is off.  
FDX/COL (green): full duplex, it is on; half duplex, it is off.

### 4.1.3. Button

- MASK / UNMASK:  
“ON”: Mask unused E1 link alarm; “OFF”: Not mask unused E1' s alarm
- RING / MUTE:  
Press on: enable the alarm ring. If alarm appears, there will be “zi...zi...” ring.  
Press off: disable the alarm ring.

### 4.1.4. DIP-Switch of front panel: (default all “OFF”)

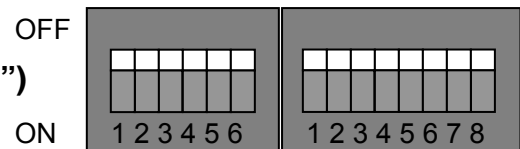

The dip-switches on the front panel are used to set E1 remote loop-back test and Ethernet port isolation functions.

- 1<sup>st</sup> on left side: enable/disable loop-back

1 <sup>st</sup>	Loop-back
OFF	Disable
ON	Enable

- 2<sup>nd</sup> ~4<sup>th</sup>: loop-back on remote site

2 <sup>nd</sup>	3 <sup>rd</sup>	4 <sup>th</sup>	Loop-back
OFF	OFF	OFF	1 <sup>st</sup> E1
OFF	OFF	ON	2 <sup>nd</sup> E1
OFF	ON	OFF	3 <sup>rd</sup> E1
OFF	ON	ON	4 <sup>th</sup> E1
ON	OFF	OFF	5 <sup>th</sup> E1
ON	OFF	ON	6 <sup>th</sup> E1
ON	ON	OFF	7 <sup>th</sup> E1
ON	ON	ON	8 <sup>th</sup> E1

Note: Only one loop-back test can be set: single E1 channel loop-back. It functions only when the loop-back is enabled and there is not alarm at the optical interface. When single E1 tributary loop-back is testing, the other tributaries are working without disturbance.

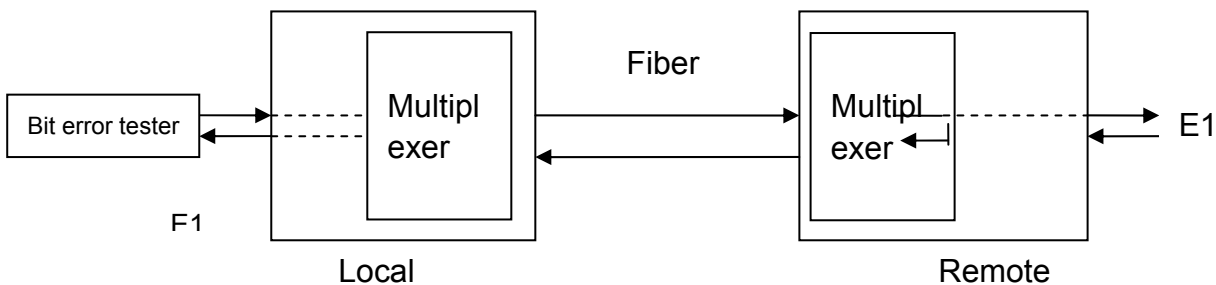

Figure: sketch map of setting remote loop-back on local site

Note: When setting loop-back on local site, the 1<sup>st</sup> – 4<sup>th</sup> bits of the DIP-switch at remote site

must be all off (no loop-back).

- 5<sup>th</sup> bit: DIP-switch for FPT

When FPT is disabled, it is identical to the AIS function of traditional optical multiplexers. When the receiving signals of the E1 interface at the remote site are lost, the corresponding local E1 interface will output all “1” signals; when the receiving signals of the local optical interface are lost, all local E1 interfaces will output all “1” signals.

FPT is designed for users who have special requirements. When FPT is enabled, if there is alarm of LOS on any direction of optical interface , E1 interfaces on both sides will not output HDB3 code. In this case, there will be LOS alarm, rather than AIS alarm, on downstream E1 terminal devices (e.g. Switches, converters or SDH devices).

5 <sup>th</sup> bit	FPT
OFF	Disable (complies with AIS)
ON	Enable

- 6<sup>th</sup> bit: setting for oversize packet

6 <sup>th</sup> bit	Definition
ON	1916 byte
OFF	1536 byte (default)

The 8-bit DIP-Switch on right side:

- The 1<sup>st</sup> – 4<sup>th</sup> bits are used for duplex setting when auto-negotiation fails

Note: supports 10/100Mbps auto-sensing and full/half duplex auto-negotiation at Ethernet port

Auto-negotiation fails: forced duplex mode according to the table shown as following

Auto-negotiation success: working on full duplex

Definition

1 <sup>st</sup>		2 <sup>nd</sup>		3 <sup>rd</sup>		4 <sup>th</sup>	
OFF	Full duplex (default)	OFF	Full duplex (default)	OFF	Full duplex (default)	OFF	Full duplex (default)
ON	Half duplex	ON	Half duplex	ON	Half duplex	ON	Half duplex

- 5<sup>th</sup> and 6<sup>th</sup> bits: Ethernet port isolation function setup

5 <sup>th</sup>	6 <sup>th</sup>	Definition
OFF	OFF	Port 1~4 can interconnect with each other, default setting
OFF	ON	Port 1~4 isolated at local site
ON	OFF	Port 1~4 isolated oppositely both on two sides (with TAG)
ON	ON	Port 1~4 isolated oppositely both on two sides (without TAG)

“Interconnect” means all users of local site can switch data with each other and with users

of remote site.

“Isolated on local site” means users of local site isolate each other; but can communicate with remote site.

“Isolated oppositely on two sides” means 1<sup>st</sup> port local site can communicate with 1<sup>st</sup> port of remote site. So do others. The “TAG” shall be added as per the customer’s requirement.

- 7<sup>th</sup> bit: network management option (RS232/485 optional)

7 <sup>th</sup> bit	Network management option
OFF	RS232 (default)
ON	RS485

When linking the LINK UP network management port with the serial port of the computer, users shall choose RS232 standard or RS485 standard. Otherwise, the communication cannot be set up.

- 8<sup>th</sup> bit: remote/local network management option

8 <sup>th</sup> bit	Network management option
OFF	Local management (default)
ON	Remote management

Note: When using the network management function, users shall set this bit of switch before connecting. The Ethernet multiplexer which LINK UP port is connected with the serial port of the computer (called local Ethernet multiplexer) shall be configured to “local management”. The one at the remote site shall be configured to “remote management”. Thus, both local and remote Ethernet multiplexers can be managed simultaneously, and the LINK UP port of remote equipment is deactivated. The topology of network management is described in the figure below.

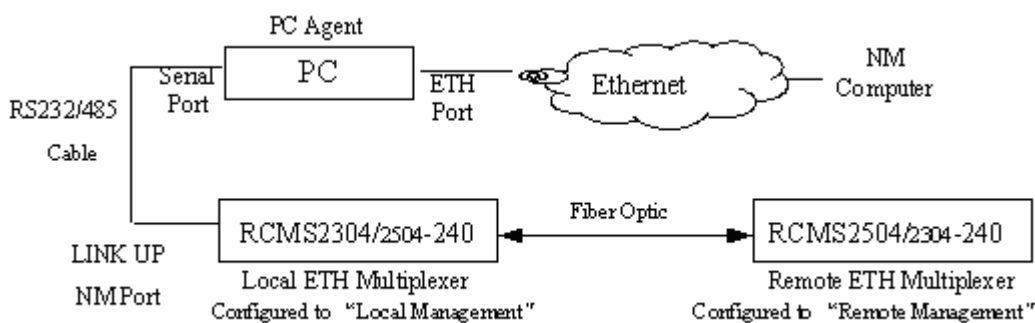

Note: the PC Agent software can be installed on the network management computer as per the customer’s requirement.

The management of remote Ethernet multiplexer is performed through the overhead bits of optical signals. This is called out-of-band network management since it will not take up any service bandwidth.

#### 4.1.5. Ethernet interface

- Each RJ45 interface corresponds to one Ethernet port. Refer to Appendix A for wire sequence.
- Each port is capable of 10/100Mbps auto-sensing
- MDI/MDIX auto-negotiation

#### 4.1.6. RS232 auxiliary data channel

Comply with RS232 standard, use and RJ45 connector. Refer to appendix A for wire sequence.

#### 4.1.7. LINK UP network management port

LINK UP port can be connected with the serial port of computer. The connection standard is optional between RS232 and RS485.

- LINK UP port: RJ45 connector. It adopts RS485 or RS232 (19.2kbps) standard.

### 4.2. Introduction of back panel

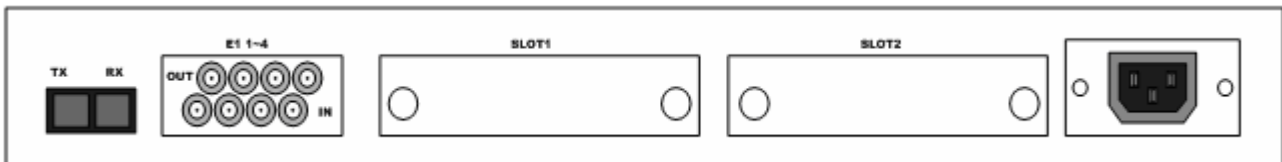

Figure: Sketch of RCMS2304-240 of back panel

#### 4.2.1. Optical interface

- Single strand, SC/PC connector

#### 4.2.2. E1 interface

A DB37 male connector on the back panel provides 1~4<sup>th</sup> E1 tributary ports. Refer to Appendix A for wire sequence.

- CC4B-8G type of adapter for conversion from DB37 to 8 CC3s is needed for using 75Ω connection. There are 1~4<sup>th</sup> E1 tributaries from left to right, where the “OUT” above and “IN” below.
- No need adapter for using 120Ω connection

### 4.2.3. SLOT1, SLOT2 expanded slots

Configuration	SLOT1	SLOT2	Capability
Basic capacity configuration	Empty	Empty	4 channel E1
Max capacity configuration	SUBM-4E1 (Provides 5 <sup>th</sup> ~8 <sup>th</sup> E1)	Empty	8 channel E1
Multi service configuration	10BaseT or V.35sub-system (occupied 5 <sup>th</sup> E1)	10BaseT or V.35sub-system (occupied 8 <sup>th</sup> E1)	4 channel E1 + multi-service interface
	100BaseT (occupied 5 <sup>th</sup> ~8 <sup>th</sup> E1)	Empty	

- Basic capacity configuration:  
Both Slot 1 and 2 are empty.
- Maximum capacity configuration (8 E1)  
Slot 1 is installed with SUBM-4E1 sub-module, which provides a DB37 male connector for the 5<sup>th</sup> – 8<sup>th</sup> E1 channels. It can be installed with adapter to provide coaxial connector. Slot 2 must be empty.
- Multi service configuration

When Slot 1 is installed with a 1 E1 interface sub-module (e.g. Ethernet to 1 E1 converter sub-module, V.35 to E1 converter sub-module), it is actually the 5<sup>th</sup> E1 channel that be occupied. If install a two-channel sub-module, it is actually the 5<sup>th</sup> and 6<sup>th</sup> channels that be occupied.

When Slot 2 is installed with a 1 E1 interface sub-module, it is actually the 8<sup>th</sup> E1 channel that be occupied. If install a two-channel sub-module, it is actually the 7<sup>th</sup> and 8<sup>th</sup> channels that be occupied. Slot 2 does not support 4-channel sub-modules.

### 4.2.4. Power supply socket

When using AC power supply, 220V standard tri-phase socket shall be used.

When using DC power supply, -48V socket shall be used. The left pin is for -48V, the right for 0V, and the middle for protecting ground.

## 4.3. DIP-Switch on the bottom panel

Please configure the DIP-Switch when power is off.

### 4.3.1. S1---S4 introduction

There are 4 DIP-switches on the bottom. The dip-switch can be set using small sharp pen or tools. Each set of dip-switch is in correspondence with E1 port.

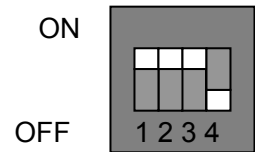

Definition as following:

1 <sup>st</sup>	2 <sup>nd</sup>	3 <sup>rd</sup>	4 <sup>th</sup>
ON	ON	ON	OFF
75Ω unbalanced signal effective			

Or

1 <sup>st</sup>	2 <sup>nd</sup>	3 <sup>rd</sup>	4 <sup>th</sup>
OFF	OFF	OFF	ON
120Ω balanced signal effective			

As shown in figure above, the default status is set as “75Ω unbalanced signal BNC interface effective”.

Note: It is suggested that use adapter for connecting 75Ω unbalanced signal; use DB37 connector for 120Ω balanced signal

## 5. Installation and test

### 5.1. Inspect after Opening

Please first check if the models and part numbers are in consistence, and also check if the equipments are damaged.

### 5.2. Preparation before Installation

- Carefully read this manual
- Prepare all kinds of the cable. Ensure that they are not short-circuited. Refer to Appendix A for cable making.
- Ensure the pressure of power supply is in the tolerance range, the chassis is well connected with the ground.
- Prepare the BERT and optical power meter for test of line quality.
- Change the dip-switch setting on the bottom panel if 120 Ohm balanced signal interface is required.
- Fix the equipment on to 19-inch rack or place the equipment at stable and secure environment. Pay attention to the requirements of the ambience.

### 5.3. Installation

#### 5.3.1. Connecting

- E1 interface

Suggest using SYV 75-2-2 coax adapter; or DB37 interface connected by twisted pair

- Ethernet

Use Cat.5 twisted pair, straight or cross over.

- Optical interface

Plug SC fiber patch cable into optical interface (push hard until to end). If not sure about transmission direction, we suggest first turn on the power of device and then plug the fiber.

- Auxiliary data channel

If you want to start the channel, connect RS232 cable at first. Avoid plugging hot swap.

- Network management port

Connect the serial port of computer to LNK-UP port. Configure the dip-switches on the bottom panel to choose RS232 or RS485 standard. Please note that the remote Ethernet multiplexer shall be set to "remote management".



### 5.3.2. Electrify

If power supply (PS) is DC -48V, first connect middle end to PGND. Turn off PS, connect “-48V” end with the lower electric level cable, “0V” end with higher electric level cable. Make sure no reverse connection, or no short circuited, and then turn on power. If PS is AC 220V, use the PS line in the accessories. When PS is turned on, the PWR indicator shall be on.

### 5.3.3. Configuring buttons and switches

After turning on power of the device, first ensure there is no alarm on optical port. If optical ports are connected properly, there shall be no LOS, LOF, and E-3 alarm. The E-6 (yellow) may be on the moment when the power is just turned on. This is because turning on the power causes jitters which results in a few bit errors. After 10 seconds, E-6 will be off. This indicator refreshes in every 10 seconds.

- Test error bit

Use 2M BER Tester to test every E1 error bit level.

- Mask unused E1 alarm

If E1 links are already connected, but there is still are unused E1 tributaries. In this case the LOS alarm of unused E1 links is called “unused E1 alarm”. Press MASK/NO MASK button “on” to clear all the unused E1 alarm and all the LOS alarm indicator of E1 tributaries are “off”.

In the case unused E1 tributary alarm being masked, if disconnection occurs at linked E1 tributary, the LOS indicator of this tributary still will be on.

If power supply is off and back to one again, then the mask function disabled. To enable mask function need press button to “off” and then pressed it to “on” again.

- Turn on the alarm ring

If after a period of operation, need new E1 tributaries to be connected, need first disable the mask function and then connect E1 link.

## 6. Troubleshooting

If you have any problems during installation and using, try to solve them by the following proposals. If there is no solution, please contact with distributors for technical support.

These following explanations and solutions of alarm for optical port and LOS alarm for E1 tributaries are analyses of local alarm. Please handle it at remote site if there is remote alarm.

- Green PWR indicator not on

Answer: PS faults. Check if PS working properly and -48 PS connection is not reverse.

- GL is on

Answer: GL is on when alarm happen in local site (L row); GL is flashing when alarm happen in remote site (R row).

Deal with them as following:

1. Besides GL there are some other alarm indicators red or yellow, please deal with these alarm at first.
2. Except GL, no alarm happens in L row. But GL is still on in local site (L row). The reason maybe is that CV alarm exists. It is arose by much longer E1 line or much disturbance or attenuating more than -6dB.
3. Except GL, no alarm happens in R row. But GL is still on in remote site (R row). The reason is that HDB3 CV alarm happened in remote site.

- LOS red indicator of optical port is on

Answer: Loss of receiving signal occurs at optical port. Check if the input fiber is connected well and if there is reverse in connection. Check the received optical power using optical power meter, it should be greater than receiving sensitivity.

- LOF red indicator of optical port is on

Answer: Loss of frame of receiving signal at optical port. In this case, optical signal has received, but the optical power may be about critical value of sensitivity. Check RX optical power to ensure if it connects well at remote optical TX port.

- E-3 red indicator is on at optical port

Answer: The bit error of optical RX signal is greater than  $10^{-3}$ . Check if optical RX port connects well and RX optical power.

- E-6 yellow indicator of optical port is on

Answer: The bit error of optical RX signal is greater than  $10^{-6}$ . It is normal that there is E-6 alarm just after turning on the power, after about 10 seconds, the E-6 indicator will be off. If there is E-6 alarm during operation, then check if optical RX port connects well and RX optical power is normal.

- LOS red indicator of E1 channel is on

Answer: Loss alarm of RX signal at E1 channel, there is no HDB3 signal received. Check if it connects well at E1 port; if the connection of 75  $\Omega$  cable reverse and if the string of 75  $\Omega$  cable in right order. If there is LOS alarm of unused E1 tributary, can press “mask” button to “on” to make alarm after configuration of device.

## 7. Appendix A Introduction of Cable Making

### A.1 E1 interface

- 75ohm adopting DB37 coax adapter:  
Suggest using SYV 75-2-2 coax cable, the distance less than 200 meter.
- 120ohm DB37 male connector is defined as following:

DB37 pin definition	1 <sup>st</sup>	2 <sup>nd</sup>	3 <sup>rd</sup>	4 <sup>th</sup>
OUT	3, 4	7, 8	11, 12	15, 16
IN	21, 22	25, 26	29, 30	33, 34

Others hang up. Twisted pairs can be jointing on DB37 female connector.

### A.2 Cable of Ethernet

Use RJ45 Cat. 5 twisted-pair cable to connect the equipment. The cable shall not be longer than 100 meters.

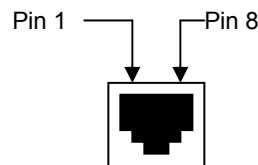

Both straight-through and crossover cables will work.

RJ45 line order as following:

Pin number	1	2	3	4	5	6	7	8
Definition	TX+	TX-	RX+	Not Used	Not Used	RX-	Not Used	Not Used

### A.3 RS232 cable of data channel

Adopting RJ45 connector, definition of pins as following:

3 —RXD 232 signal input

6 —TXD 232 signal output

4, 5 —GND

others — hang up (unassigned)

RS232 (RJ45) connect to console of computer (DB9 female connector) line order:

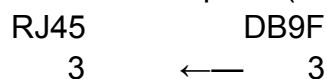

6	→	2
4, 5	—	5

# **BROADBAND to RAISECOM**

@2005 Raisecom Technology Co., Ltd.

All trademarks are the property of their respective owners.

Technical information may be subject to change without prior notification.